

Shinba

Digital Indicating Controllers
ACD-13A, ACR-13A

ON/OFF SERVO Digital Indicating Controllers
ACD-15A, ACR-15A

Indicating Controller

Distinguished Control

Visibility,
Functionality



Simplified setting – Set frequently used settings for streamline

Easy status checking using 3-color switching

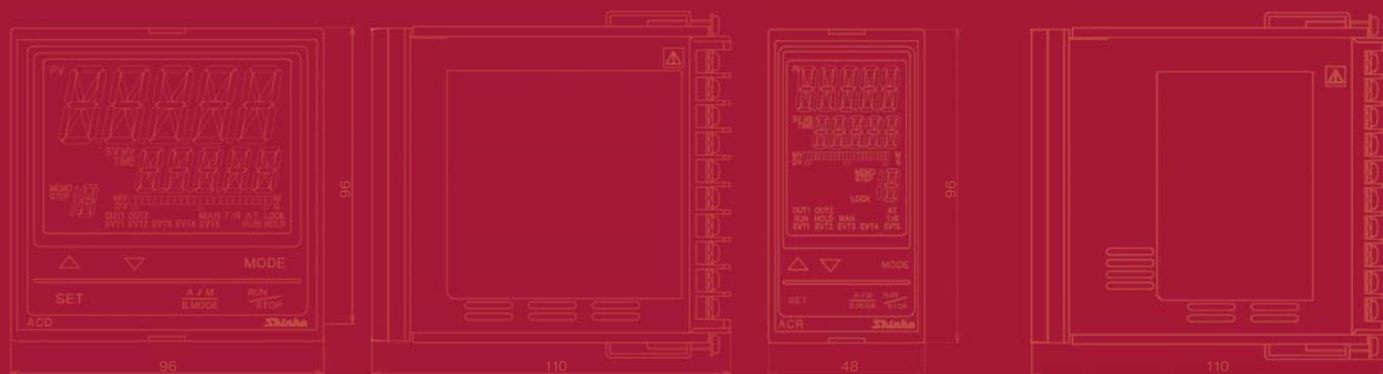

Industry leading large display

Easier viewing display



Industry Leading Large Display

Multi-Functions, Simple to Operate

Large LCD display

A specially treated large LCD display makes it easier to view even in bright light and open-air.

PV display (ACD series): 24.0 x 11.0mm (H x W)



ACD series



JCD-33A

An easily viewable bar graph

22-segment bar graph allows simultaneous PV, SV, MV viewing.

Ease of viewing for manual output operation.

For the ACD-15A and ACR-15A, the motor valve opening can be checked with the bar graph. (when feedback potentiometer "Yes" is set)

MV indication	DV indication
Scale is -5 to 105%, and bars light increasingly to the right in accordance with the MV.	In the case of zero (0) deviation, central 2 bars light. For positive deviation, bars light increasingly to the right. For negative deviation, bars light increasingly to the left.
<ul style="list-style-type: none"> (e.g.) MV 50% 	<ul style="list-style-type: none"> (e.g.) Deviation 0 (zero)
<ul style="list-style-type: none"> (e.g.) MV 100% 	<ul style="list-style-type: none"> (e.g.) Negative deviation

Enhanced visibility

PV display color selectable from red, green and orange.

Colors can be set depending on the deviation between PV and SV, so status can be checked from a distance.

● PV color continuous change mode

When PV is higher than the setting range



When PV is within the setting range



When PV is lower than the setting range



● It is easier to see the SV, PV and setting characters, as an 11-segment LCD display is used.



All segments are backlit



SENS



ARW

● PV display color is selectable from 7 modes below.

- PV display: Green, Red, Orange
- Event output (any event from EVT1 to EVT5)
Alarm OFF: Green, Alarm ON: Red
Alarm OFF: Orange, Alarm ON: Red
- PV color changes continuously : Orange→Green→Red
- PV color changes continuously + Event output (any event from EVT1 to EVT5) ON (Red)

Digital Indicating Controllers

ACD-13A, ACR-13A

ON/OFF SERVO Digital Indicating Controllers

ACD-15A, ACR-15A



Actual size

PID zone function: PID resetting due to SV change Unnecessary

Up to 5 groups of PID parameters can be set.

When SV is changed, PID parameters are automatically changed for optimal control. (It is not necessary to reset PID after SV is changed.)

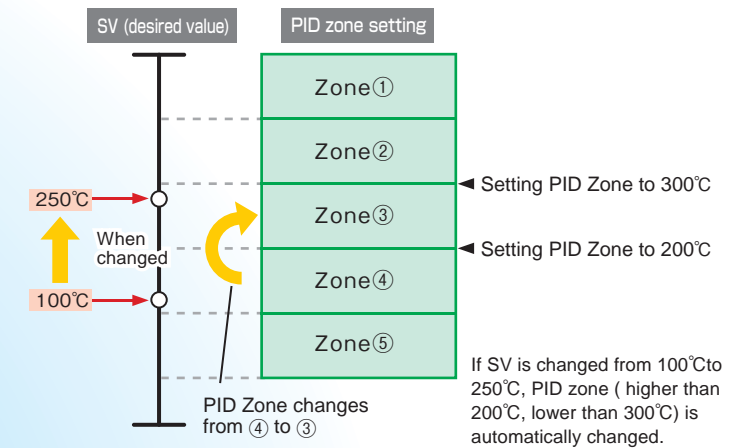

Simple operation in Simplified setting mode

Without setting engineering items, simplified setting mode can prevent operational mistakes, and simple operations run smoothly. Basic settings and key operations now are doable via 3-key usage.



Power unnecessary if USB comm. cable used

If CMB-001 USB communication cable (sold separately) is used, a power supply for the controller is not necessary. Wiring for the Initial setting is reduced. Data logging and monitoring can be carried out via the monitoring software (sold separately).

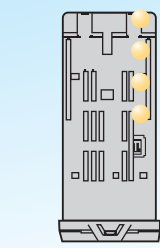

ACR-13A bottom

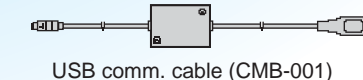

USB comm. cable (CMB-001)

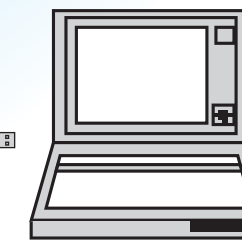

PC



Setting displays

Feedback potentiometer "Yes/No" selectable

Selectable using the front keypad. If "Yes" is selected, feedback potentiometer position Fully Closed/Fully Open can be automatically adjusted. If "No" is selected, it is manually adjustable (only for ACD-15A, ACR-15A).

Model

ACD - 1	<input type="checkbox"/>	A -	<input type="checkbox"/>	/M	<input type="checkbox"/>	<input type="checkbox"/>	<input type="checkbox"/>	<input type="checkbox"/>	W96×H96mm
ACR - 1	<input type="checkbox"/>	A -	<input type="checkbox"/>	/M	<input type="checkbox"/>	<input type="checkbox"/>	<input type="checkbox"/>	<input type="checkbox"/>	W48×H96mm
Control action	3								PID
	5								ON/OFF servo output PID
A1	A								Selectable with the keypad operation (*1)
Control output (OUT1)	R								Relay contact :1a1b (ACx-15A: 1a x 2)
	S								Non-contact voltage(SSR drive): 12VDC ±15%
	A								DC current: 4 to 20mA DC
Input	M								Multi-range (*2)
Supply voltage									100 to 240V AC(Standard)
	1								24V AC/DC (*3)
Option (Multiple options selectable)	EI								Event input (*5)
	A3								Event output (EVT1 to EVT3) (*4)(*6)(*7)
	A5								Event output (EVT4, EVT5)
	W								Single-phase
	W3								3-phase
	DR								Relay contact: 1a
	DS								Non-contact voltage (SSR drive):12V DC±15%
	DA								DC current: 4 to 20mA DC
	C								RS-232C
	C5								RS-485
	EA1								4 to 20mA DC
	EA2								0 to 20mA DC
	EV1								0 to 1V DC
	EV2								1 to 5V DC
	TA1								4 to 20mA DC
	TV1								0 to 1V DC
P									Insulated power output 24V DC (*4)(*6)(*7)

(*1): Alarm types (12 types and No alarm action) and status Energized/De-energized can be set by front keypad.

(*2): Thermocouple, RTD, DC current or DC voltage is selectable by front keypad.

(*3): For the supply voltage, 100 to 240V AC is standard.

When ordering 24V AC/DC, enter "1" after the input code.

(*4): Applicable to the ACD-13A, ACR-13A.

(*5): If EI and C/C5 options are added together, Event input EVI3 and EVI4 cannot be used.

(*6): A3, D□ and P options cannot be added together.

(*7): If D□ and P options are added, Event output EVT2 cannot be used.

(*8): The rated current (20A, 100A) for single phase and 3-phase is selectable by front keypad. The CT is sold separately. Not available for the DC current output type.

Rated scale

Input		Scale range		Resolution
Thermocouple	K	-200 to 1370 °C	-328 to 2498 °F	1 °C (°F)
		-200.0 to 400.0 °C	-328.0 to 752.0 °F	0.1 °C (°F)
	J	-200 to 1000 °C	-328 to 1832 °F	1 °C (°F)
	R	0 to 1760 °C	32 to 3200 °F	1 °C (°F)
	S	0 to 1760 °C	32 to 3200 °F	1 °C (°F)
	B	0 to 1820 °C	32 to 3308 °F	1 °C (°F)
	E	-200 to 800 °C	-328 to 1472 °F	1 °C (°F)
	T	-200.0 to 400.0 °C	-328.0 to 752.0 °F	0.1 °C (°F)
	N	-200 to 1300 °C	-328 to 2372 °F	1 °C (°F)
	PL-II	0 to 1390 °C	32 to 2534 °F	1 °C (°F)
C(W/Re5-26)	0 to 2315 °C	32 to 4199 °F	1 °C (°F)	
RTD	Pt100	-200.0 to 850.0 °C	-328.0 to 1562.0 °F	0.1 °C (°F)
		-100.0 to 100.0 °C	-148.0 to 212.0 °F	0.1 °C (°F)
		-100.0 to 500.0 °C	-148.0 to 932.0 °F	0.1 °C (°F)
	JPt100	-200 to 850 °C	-328 to 1562 °F	1 °C (°F)
		-200.0 to 500.0 °C	-328.0 to 932.0 °F	0.1 °C (°F)
		-200 to 500 °C	-328 to 932 °F	1 °C (°F)
DC current	4 to 20mA			
	0 to 20mA			
DC voltage	0 to 10mV			
	-10 to 10mV			
	0 to 50mV			
	0 to 100mV			
	0 to 1V			
	0 to 5V			
	1 to 5V			
	0 to 10V			

*1: Decimal point place change and scaling are possible.

Standard specifications

Display	PV display : 11-segment LCD 5-digit, backlight Red/Green/Orange, Character size: ACD: 24.0x11.0mm(HxW), ACR: 14.0x5.4mm(HxW) SV/MV/TIME display : 11-segment LCD 5-digit, backlight Green, Character size: ACD: 14.0x7.0mm(HxW), ACR: 10.0x4.6mm(HxW) MV/DV bar graph : 22-segment LCD bar graph, backlight Green MEMO/STEP display : 11-segment LCD 2-digit, backlight Orange, Character size: ACD: 10.0x5.0mm(HxW), ACR: 10.0x4.6mm(HxW)
Rated input	Thermocouple : K, J, R, S, B, E, T, N, PL-II, C(W/Re5-26), External resistance, 100Ω or less (However, B input: External resistance, 40Ω or less) RTD : Pt100, JPt100, 3-wire system Allowable input lead wire resistance: 10Ω or less per wire DC current : 0-20mA DC, 4-20mA DC Input impedance: 50Ω Allowable input current, 50mA or less DC voltage : 0-10mV DC, -10-10mV DC, 0-50mV DC, 0-100mV DC, 0-1V DC: Input impedance: 1MΩ or more Allowable input voltage: 5V DC or less Allowable signal source resistance: 0-10mV DC: 20Ω or less, -10-10mV DC: 40Ω or less, 0-50mV DC: 200Ω or less, 0-100mV DC: 200Ω or less, 0-1V DC: 2kΩ or less 0-5V DC, 1-5V DC, 0-10V DC: Input impedance: 100kΩ or more Allowable input voltage: 15V DC or less Allowable signal source resistance: 100Ω or less
Accuracy (Setting, Indication)	Thermocouple : Within ±0.2% of each input span±1digit, However R, S input, -50 to 200°C (-58 to 392°F): Within ±6°C (12°F) B input, 0 to 300°C (0 to 572°F): Accuracy is not guaranteed. K, J, E, T, N input, less than 0°C (32°F): Within ±0.4% of input span±1digit RTD : Within ±0.1% of each input span±1digit DC current : Within ±0.2% of each input span±1digit DC voltage : Within ±0.2% of each input span±1digit Cold junction temperature compensation accuracy: Within ±1°C at 0 to 50°C
Input sampling period	125ms (250ms when EA1/EA2 or EV1/EV2 option is added)
Control output	ACD-13A, ACR-13A Relay contact : 1a 1b, Control capacity; 3A 250V AC (resistive load), 1A 250V AC (inductive load cosφ=0.4), Electrical life, 100,000 cycles Non-contact voltage (for SSR drive): 12V DC±15% Max. 40mA (short circuit protected) DC current : 4 to 20mA DC (Resolution 1/12000) Load resistance, Maximum 600Ω ACD-15A, ACR-15A Relay contact : 1ax2, Control capacity; 3A 250V AC (resistive load), 1A 250V AC (inductive load cosφ=0.4), Electrical life, 100,000 cycles
FBP resolution	1/1000 (corresponds to fully open and fully closed by FBP adjustment) (ACD-15A, ACR-15A)
Control action	PID action (with auto-tuning function), PI, PD action (with Auto/Manual reset function), P action (with Auto/Manual reset function), ON/OFF action OUT1 proportional band (P) : 0 to Input span°C(°F) or 0.0 to 1000.0% (ON/OFF action when set to 0 or 0.0) (Default: 10°C) OUT1 Integral time (I) : 0 to 3600sec (OFF when set to 0) (Default: 200sec) OUT1 Derivative time (D) : 0 to 1800sec (OFF when set to 0) (Default: 50sec) OUT1 proportional cycle (*1) : 1 to 120sec (Default: Relay contact; 30sec, Non-contact voltage; 3sec, DC current; Not available) ARW : 0 to 100% (Default: 50%) OUT1 ON/OFF action hysteresis : 0.1 to 1000.0°C(°F) or 1 to 10000 (The placement of the decimal point follows the selection) (Default: 1.0°C) OUT1 high limit, low limit : 0 to 100% (DC current: -5 to 105%) (Not available for ON/OFF action) (Default: OUT1 low limit; 0%, OUT1 high limit; 100%) MV high limit, low limit (*2) : 0 to 100% (Not available for ON/OFF action) (Default: MV low limit; 0%, MV high limit; 100%) Open output time (*2) : 0.1 to 1000.0sec (Default: 30.0sec) Closed output time (*2) : 0.1 to 1000.0sec (Default: 30.0sec) Output time corresponds to the MV 0 to 100%. Open/Closed output dead band (*2) : 0 to 100% of the proportional band (Default: 10%) Open/Closed output hysteresis (*2) : 0 to 100% of the proportional band (Default: 1%) (*1): ACD-13A, ACR-13A, (*2): ACD-15A, ACR-15A
EVT output	EVT1 output Output: Relay contact 1a, Control capacity: 3A 250V AC (resistive load), 1A 250V AC (inductive load cosφ=0.4), Electrical life: 100,000 cycles EVT2 output Output: The same as EVT1 If DR/DS/DA or P option is added, EVT2 output is disabled.

EVT output	<p>Alarm action Alarm types: High limit alarm, Low limit alarm, High/Low limits alarm, High/Low limits independent, High/Low limit range, High/Low limit range independent, Process high alarm, Process low alarm, High limit alarm with standby, Low limit alarm with standby, High/Low limits with standby, High/Low limits with standby independent One type can be selected from 24 types (with status Energized/De-energized) and No event. (Default value: No event) Setting accuracy : Based on the Accuracy and Cold junction temperature compensation accuracy Action : ON/OFF action Hysteresis : Thermocouple, RTD input : 0.1 to 1000.0°C (°F) DC voltage, current input : 1 to 10000 (The placement of the decimal point follows the selection) Output : EVT output for which alarm is selected during Event output allocation</p> <p>Loop break alarm Setting range : Loop break alarm time: 0 to 200minutes Loop break alarm span: TC, RTD input; 0 to 150°C(°F), 0.0 to 150.0°C(°F) DC voltage, current input: 0 to 1500 (The placement of the decimal point follows the selection) Output : EVT output for which Loop break alarm is selected during Event output allocation.</p>
Supply voltage	100 to 240V AC 50/60Hz(Allowable fluctuation range: 85 to 264V AC), 24V AC/DC 50/60Hz(Allowable fluctuation range: 20 to 28V AC/DC)
Power consumption	Approx. 13VA
Insulation resistance	10MΩ or more, at 500V DC
Dielectric strength	Between power terminal and ground : 1.5kV AC for 1 minute Between input terminal and ground : 1.5kV AC for 1 minute Between input terminal and power terminal : 1.5kV AC for 1 minute
Environment	Ambient temperature: 0 to 50°C Ambient humidity: 35 to 85%RH (Non-condensing) Conforms to RoHS directive.
Case Material/Color	Material: Flame-resistant resin, Color: Black
Mounting, Setting	Mounting: Flush Setting: Sheet key input
Dimensions, Weight	Dimensions: ACD: 96x96x110mm (WxHxD), ACR: 48x96x110mm (WxHxD) Weight: ACD: Approx. 460g, ACR: Approx. 330g
Attached functions	Sensor correction, Set value lock, Auto/Manual control, Program control function, Set value ramp function, Power failure countermeasure, Self-diagnosis, Automatic cold junction temperature compensation, Burnout (overscale), Input abnormality indication, Indication range / Control range, Warm-up indication, Console communication, PV color selection, Timer function, Bar graph, PID zone function.
Accessories included	Mounting brackets 1 set, Gasket (Front mounted to the unit) 1 piece Instruction manual 1 copy, Communication instruction manual 1 copy (when C or C5 option is added) For the ACR only: Harness EVT5 : 1 piece [When Event output (A5 option) is added] Harness W : 1 piece [When Heater burnout alarm (W option) is added] (ACR-13A) Harness W : 2 pieces [When Heater burnout alarm (W3 option) is added] (ACR-15A) Harness E : 1 piece [When External setting input (EA1, EA2, EV1, EV2 option) is added] Harness VT : 1 piece [When Transmission output (TA1, TV1 option) is added] Harness FBP : 1 piece (ACR-15A)
Accessories sold separately	Terminal cover, Heater burnout alarm (W, W3 option): 20A; CT (CTL-6S), 100A; CT (CTL-12-S36-10L1U), USB communication cable (CMB-001)

■ Optional specifications

EVT input [EI]	An Event input comprises events from EV1 to EV14. Events selected from Event input allocation will be performed depending on the Input ON (Closed) or OFF (Open) status. If Set value memory function is selected: 2 ⁰ , 2 ¹ , 2 ² and 2 ³ will be allocated to Event input EV1 to EV14 respectively, and SV1 to SV15 will be determined by each value of EV1 to EV14. The selected memory number is indicated on the MEMO/STEP display. If this option and Serial communication (C, C5 option) are added together, Event input EV13 and EV14 cannot be used.
Event output [A3] (*), Event output [A5]	A3: EVT1 to EVT3 will be added using a common terminal. Output will be turned ON or OFF depending on the conditions selected from Event output allocation. If EVT3 (A3 option) is added, Heating/Cooling control (DR/DS/DA option) or Insulated power output (P option) cannot be added together. A5: EVT4 and EVT5 can be added. Output will be turned ON or OFF depending on the conditions selected from Event output allocation. Output: Relay contact 1a, Control capacity: 3A 250V AC(resistive load), 1A 250V AC (inductive load cosφ=0.4), Electrical life: 100,000 cycles
Heater burnout alarm [W, W3] (*)	Rating : Single-phase 20A, 3-phase 20A, Single-phase 100A, 3-phase100A (Selectable by keypad) Single-phase: Detects burnout with CT1 input 3-phase: Detects burnout with CT1 and CT2 input Setting range : 0.0 to 20.0A for Heater rated current 20A [W(20A) W3(20A)] (Off when set to 0.0) 0.0 to 100.0A for Heater rated current 100A [W(100A) W3(100A)] (Off when set to 0.0) Setting accuracy : ±5% of the rated current Action point : Set value Action : ON/OFF action Output : Relay contact 1a, Control capacity: 3A 250V AC (resistive load), 1A 250V AC (inductive load cosφ=0.4), Electrical life: 100,000 cycles
Heating/Cooling control Output [DR, DS, DA] (*)	Heating control action: The same as Control output (OUT1) Cooling control action: OUT2 proportional band : 0.0 to 10.0 times OUT1 proportional band (ON/OFF action when set to 0.0) OUT2 integral time, OUT2 derivative time: The same as those of OUT1 OUT2 proportional cycle : 1 to 120sec [Default: DR: 30sec, DS: 3sec, DC current (DA); Not available] Overlap/Dead band setting range : TC, RTD input: -200.0 to 200.0°C(°F), DC input: -2000 to 2000 (The placement of the decimal point follows the selection) OUT2 ON/OFF action hysteresis : TC, RTD input: 0.1 to 1000.0°C(°F) (Default: 1.0°C), DC input: 1 to 10000 (The placement of the decimal point follows the selection) OUT2 high limit, OUT2 low limit : 0 to 100% (DC current output: -5 to 105%) (Not available for ON/OFF action) (Default: OUT2 low limit; 0%, OUT2 high limit; 100%) OUT2 action mode : (1) Air cooling (linear characteristic) (2) Oil cooling (1.5th power of the linear characteristic) (Default: Air cooling) (3) Water cooling (2nd power of the linear characteristic) (Default: Air cooling) Output DR: Relay contact, 1a, Control capacity: 3A 250V AC (resistive load), 1A 250V AC (inductive load cosφ=0.4), Electrical life: 100,000 cycles DS: Non-contact voltage (for SSR drive) 12V DC±15%, Max. 40mA DC (short circuit protected) DA: DC current 4 to 20mA DC, Resolution (1/12000), Load resistance: Max. 600Ω If this option is added: Event output (A3 option) or Insulated power output (P option) cannot be added together, and Event output EVT2 cannot be used.
Serial communication [C, C5]	This option and Console communication cannot be used together. The following operations can be carried out from the external computer. (1) Reading and setting of the SV (desired value), PID values and various set values (2) Reading of the PV (process variable) and action status (3) Function change Communication line : EIA RS-485 (C5 option), EIA RS-232C (C option) Communication method : Half-duplex communication Synchronization method : Start-stop synchronization Communication speed : 9600, 19200, 38400bps Selectable by keypad (Default: 9600bps) Data bit/Parity : 7, 8/ Even, Odd and No parity (Selectable by keypad) (Default: 7 bits/Even parity) Stop bit : 1, 2 (Selectable by keypad) (Default: 1) Communication protocol : Shinko protocol/Modbus ASCII/Modbus RTU (Selectable by keypad) (Default: Shinko protocol) Number of connectable units : 1 unit to 1 host computer (C), Maximum 31 units to 1 host computer (C5) Communication error detection: Parity, checksum (Shinko protocol), LRC (Modbus ASCII), CRC-16 (Modbus RTU) Digital external setting : Receives digital set values from Shinko programmable controllers (PC-900, PCD-33A with SVTC option). If this option and Event input (E1 option) are added together, Event input EV13 and EV14 cannot be used.
External setting input [EA1, EA2, EV1, EV2]	SV adds external analog signal to remote bias value. Setting signal : DC current: 4 to 20mA (EA1 option), 0 to 20mA (EA2 option) DC voltage: 0 to 1V (EV1 option), 1 to 5V (EV2 option) Allowable input : EA1, EA2: 50mA DC or less, EV1: 5V DC or less, EV2: 10V DC or less Input impedance : EA1, EA2: 50Ω, EV1, EV2: 100kΩ Input sampling period: 250ms
Transmission output [TA1, TV1]	Converting the value (PV, SV, MV or DV) to analog signal every 125ms, outputs the value in current or voltage. (Default: PV transmission) Outputs Transmission output low limit value (4mA DC or 0V DC) if Transmission output high limit and low limit value are the same. Resolution : 1/12000 Output : TA1: 4 to 20mA DC (load resistance, Max. 500Ω), TV1: 0 to 1V DC (load resistance, Min. 100kΩ) Output accuracy : Within ±0.3% of Transmission output span
Insulated power output [P] (*)	Output voltage : 24±3V DC (when load current is 30mA DC) Ripple voltage : Within 200mV DC (when load current is 30mA DC) Max. load current: 30mA DC If this option is added: Event output (A3 option) or Heating /Cooling control (DR/DS/DA option) cannot be added together, and Event output EVT2 cannot be used.

(*) : Applicable to the ACD-13A, ACR-13A.

External dimensions (Scale: mm)

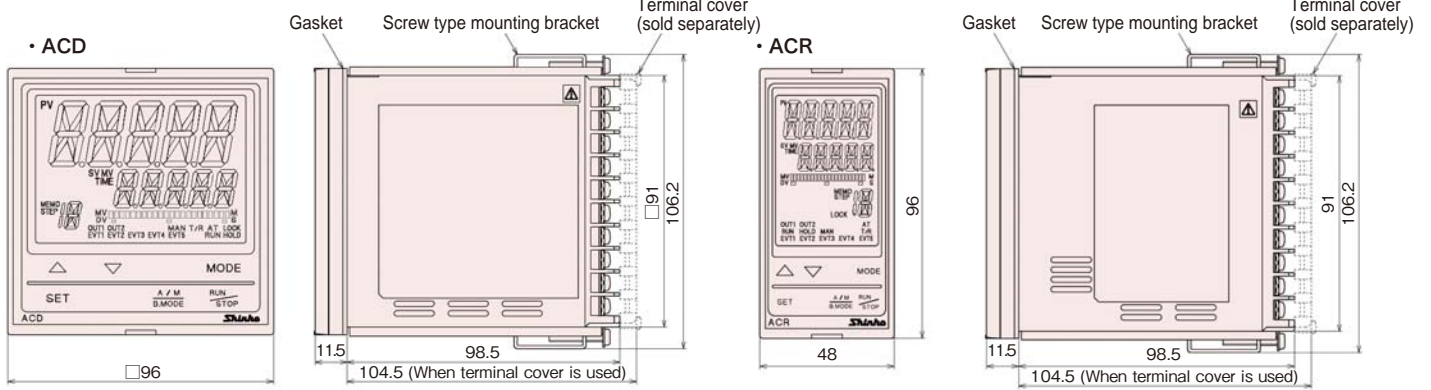

Terminal arrangement

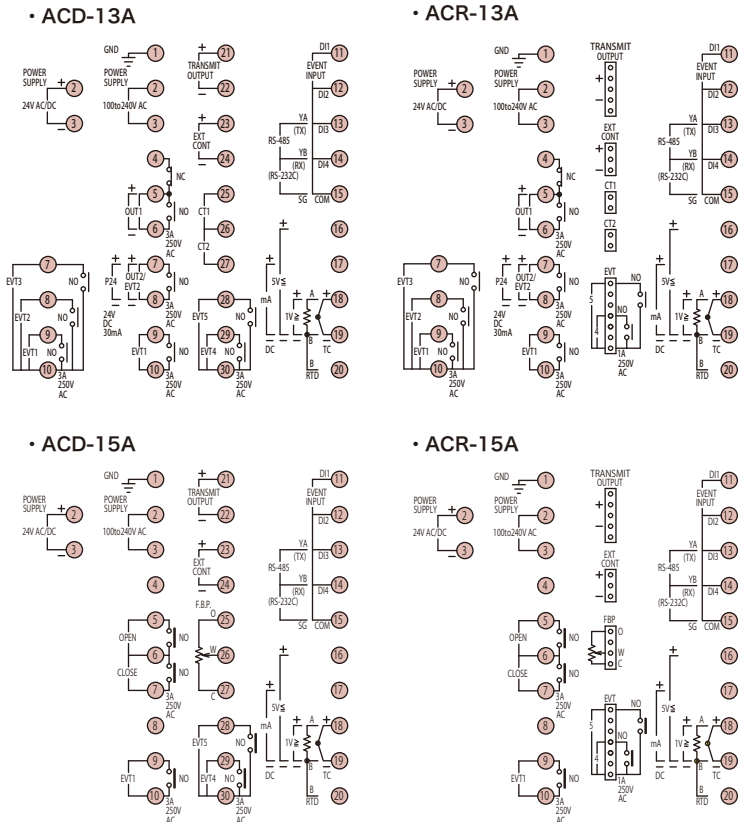

Panel cutout (Scale: mm)

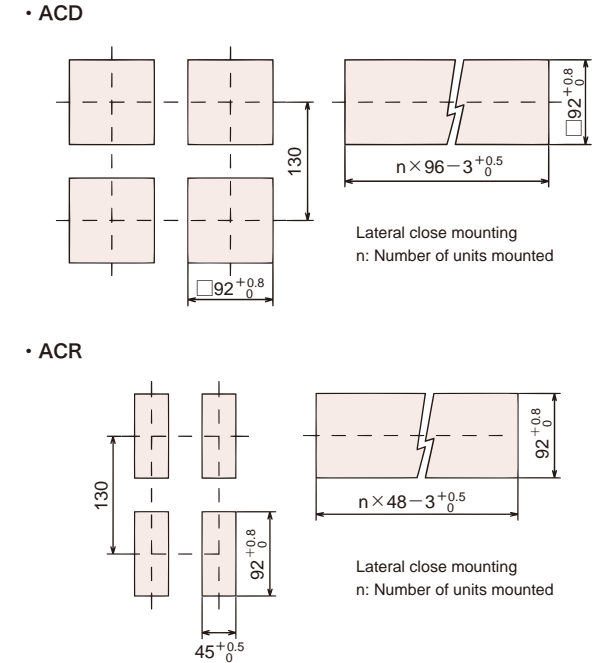

Caution
If lateral close mounting is used for the controller, IP66 specification (Dust-proof/Drip-proof) may be compromised, and all warranties will be invalidated.

Solderless terminal

Use a solderless terminal with an insulation sleeve in which the M3 screw fits. The torque should be 0.63N·m.

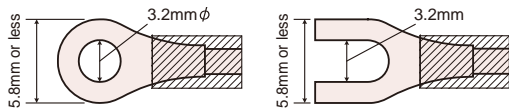

Caution

- This controller does not have a built-in power switch, circuit breaker or fuse. It is necessary to install them near the controller.
- For a 24V AC/DC power source, do not confuse polarity when using direct current (DC).

SAFETY PRECAUTIONS

- To ensure safe and correct use, thoroughly read and understand the manual before using this instrument.
- This instrument is intended to be used for industrial machinery, machine tools and measuring equipment. Verify correct usage after consulting purpose of use with our agency or main office. (Never use this instrument for medical purposes with which human lives are involved.)
- External protection devices such as protection equipment against excessive temperature rise, etc. must be installed, as malfunction of this product could result in serious damage to the system or injury to personnel. Also proper periodic maintenance is required.
- This instrument must be used under the conditions and environment described in the manual. Shinko Technos Co., Ltd. does not accept liability for any injury, loss of life or damage occurring due to the instrument being used under conditions not otherwise stated in this manual.

Caution with respect to Export Trade Control Ordinance

To avoid this instrument from being used as a component in, or as being utilized in the manufacture of weapons of mass destruction (i.e. military applications, military equipment, etc.), please investigate the end users and the final use of this instrument. In the case of resale, ensure that this instrument is not illegally exported.

This catalog is as of August 2009 and its contents are subject to change without notice.
If you have any inquiries, please consult us or our agency.

SHINKO TECHNOS CO., LTD. OVERSEAS DIVISION

Reg. Office : 2-5-1, Senbahigashi, Minoo, Osaka, 562-0035, Japan
Tel : 81-72-727-6100
Fax : 81-72-727-7006
URL : <http://www.shinko-technos.co.jp>
E-mail : overseas@shinko-technos.co.jp